

# › Electronic Counters

## Multifunction Counter

### CTR48

- › Multicoloured LCD display (green-red)
- › Maximum input frequency 40 k Hz
- › Simple parameter setting, configuration using text menus
- › Easy modification of presets
- › Reset on panel or external with inhibition option
- › Option of locking the keypad, completely or partially (preset, programming)
- › IP 65 sealed panel
- › Highly resistant to shocks and impacts
- › Excellent visibility due to the large digit size (2 lines, 6 digits)



CTR48

Product selection						
Model	Type	Functions	Preset	Voltages	Output	Part Number
CTR48	Multicoloured LCD display (green-red)	Preselection counter, Tachometer, Chronometer, Batch counters, Impulse counter	2	90 → 260 V~	5 A changeover relay, 1 NO relay, 2 solid state	<b>87621225</b>

Accessories	
Description	Part Number
Adaptor for 72 x 72 mm cut-out	<b>26546842</b>
Adaptor for 55 x 55 mm cut-out	<b>26546846</b>
DIN rail adaptor	<b>26546841</b>

General characteristics	
Physical details and protection	
Supply	90 → 260 V~
Relative humidity at 40 ° (no condensation) according to EN 60068-2-30	93%
Altitude	Up to 2 000 m
Certifications	UL - cULus - CE
Vibration resistance in 3 axes	10-55 Hz/1 min/XYZ EN 60068-2-6: 30 min. in each direction
Connection by screw terminals	Removable
Protection	Front side: IP65 / Connections: IP20
Front panel watertight seal	•
Temperature limits use (°C)	-20 → +65
Temperature limits stored (°C)	-25 → +75
Weight (g)	250

You have a project? Contact us on [www.crouzet.com](http://www.crouzet.com)

#### Description:

#### Crouzet Impulse Counters, accurate and durable solutions for pulse measurement needs

Crouzet's electronic impulse counters are reliable devices designed for measuring and recording electrical impulses in industrial applications. Crouzet's impulse counters use a combination of mechanical and electrical components to precisely count electrical pulses, offering a reliable solution for various industrial control and monitoring tasks.

For more information about: please visit [www.crouzet.com](http://www.crouzet.com)

Specifications	
Reset to zero or to preset	On panel: if not locked during programming Electrical: automatic, voltage or solid state (NPN or PNP depending on programming)
Minimum pulse time	Impulse counter: < 15 ms Chronometer: 500 µs
Option to protect against reset from front panel	•
Scale factor (each input pulse is multiplied by this figure)	00.0001 → 99.9999
Scaling factor (each input impulse is divided by this value)	01.0000 → 99.9999
Decimal point selectable for ease of reading	0 0.0 0.00 0.000 0.0000 0.00000
Sensor supply version AC	24 V $\overline{\text{---}}$ -20/+15 % 50 mA
Programming and current value backed up via EEPROM memory	• Service life 10 years
Operating characteristics	
Functions	Preselection counter, Tachometer, Chronometer, Batch counters, Impulse counter
Number of presets	2
Display	Multicoloured LCD (green-red)
Height digits (mm)	9
Display details	999 999 → 999 999
Input specifications	
Inputs	2 counter inputs 1 reset input, 1 gate input
Input modes	Dir: Directional AS: up/dn AA: up/up PP: phase PP2: phase 2 PP4: phase 4
Input type	Voltage or solid state
High level	8 V $\overline{\text{---}}$ → 30 V $\overline{\text{---}}$
Low level	0 → 2 V $\overline{\text{---}}$
Solid state output characteristics	
Maximum current (mA)	30
Max. voltage	24 V $\overline{\text{---}}$ -20/+15 %
Relay output characteristics	
Changeover relay	•
NO contact	Depending on version
Maximum current (A)	5
Minimum current (mA)	10
Maximum voltage	30 V $\overline{\text{---}}$ / 250 V $\sim$
Min. voltage	5 V $\overline{\text{---}}$
Response time (ms)	< 13 ms
Mechanical life (operations)	20 x 10 <sup>6</sup>
Number of operations to 5 A	5 x 10 <sup>4</sup>
Output modes: maintained or pulsed	0.01 → 99.99 s

**Principles**

**Display and buttons**

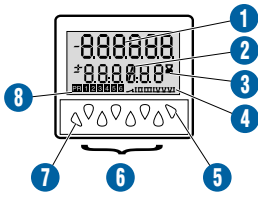

- ① Current value
- ② Selected value
- ③ Chronometer display
- ④ Active output indication
- ⑤ Prog/mode button
- ⑥ Preset control buttons
- ⑦ Button required for programming parameters
- ⑧ Shows which value is displayed

**Dimensions (mm)**

**Panel Mounted**

**CTR48**

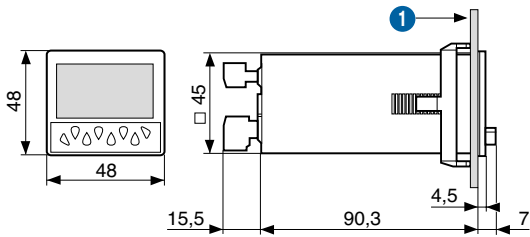

- ① 10.5 max

**Panel Cut-out**

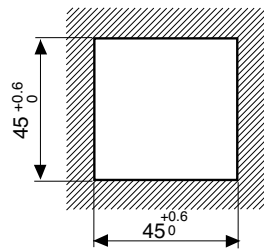

**Accessories**

**26546842 - Adaptor for 72 x 72 mm cut-out**

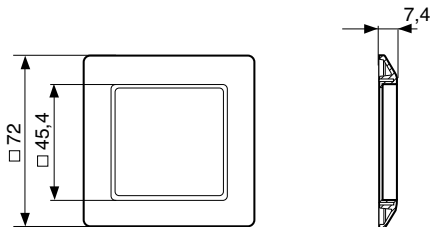

**26546846 - Adaptor for 55 x 55 mm cut-out**

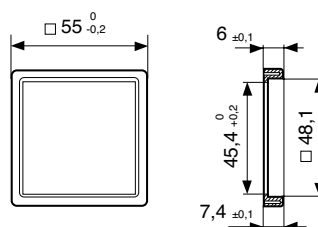

26546841 - DIN rail adaptor

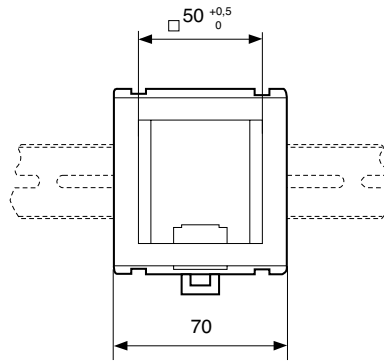
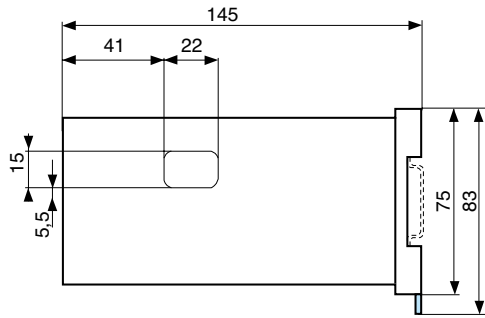

Curves

Counter: dir

dir

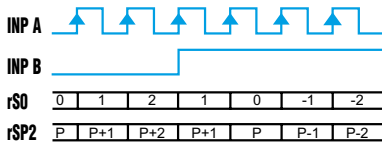

Counter: AS

AS

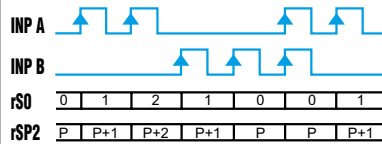

Inp A: counter input / Inp B: count direction / rS0: Display 0 → Preset / rSP2: Display Preset → 0

Inp A: Add. counter input 1 / Inp B: Sub. counter input 2 / rS0: Display 0 → Preset / rSP2: Display Preset → 0

Counter: AA

AA

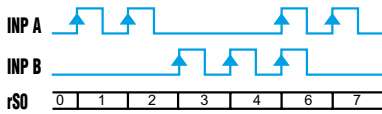

Counter: PP

PP

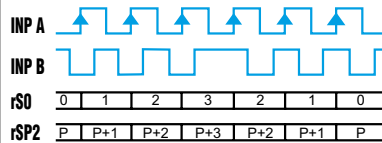

Inp A: Add. counter input 1 / Inp B: Sous. counter input / 2 rS0: Display 0 → Preset

A 90 ° B Inp A: Counter input Counting on an edge / Inp B: Reversal of direction / rS0: Display 0 → Preset / rSP2: Display Preset → 0

Counter: PP2

PP2

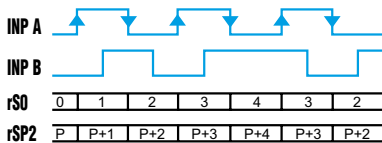

Counter: PP4

PP4

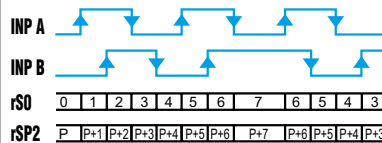

A 90 ° B Inp A: Counter input Counting on a rising edge and on a falling edge / Inp B: Reversal of direction / rS0: Display 0 → Preset / rSP2: Display Preset → 0

A 90 ° B Inp A: Counter input Counting on a rising edge and on a falling edge / Inp B: Counter input Counting on a rising edge and on a falling edge, reversal of direction / rS0: Display 0 → Preset / rSP2: Display Preset → 0

Chronometer: Start tcCb

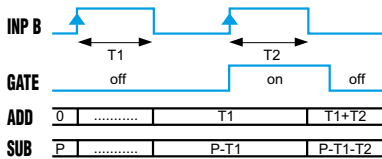

Chronometer: Start tcCbb

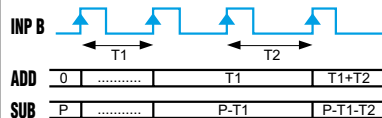

Inp A: No function / Inp B: On/Off Cumulative time counting / Add: Display 0 → Preset / Sub: Display Preset → 0

**Chronometer: Start tcCAb**

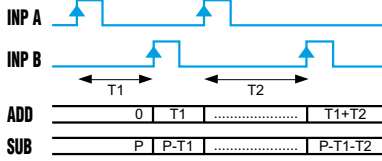

Inp A: On / Inp B: Off Cumulative time counting / Add: Display 0 → Preset / Sub: Display Preset → 0

**Chronometer: Start tcSb**

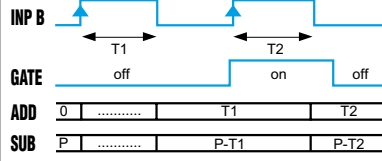

Inp A: No function / Inp B: On/Off Individual time counting while B is active, automatic reset before each new count / Add: Display 0 → Preset / Sub: Display Preset → 0

**Chronometer: Start tcSbb**

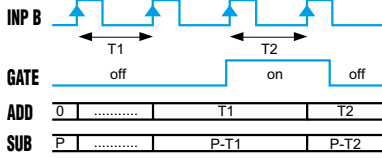

Inp A: No function / Inp B: On/Off Individual time counting, automatic reset before each new count / Add: Display 0 → Preset / Sub: Display Preset → 0

**Chronometer: Start tcSAb**

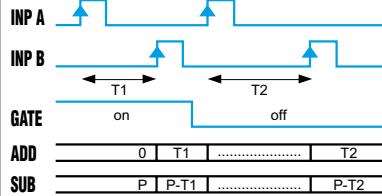

Inp A: On / Inp B: Off Individual time counting, automatic reset before each new count / Add: Display 0 → Preset / Sub: Display Preset → 0

**Chronometer: Start tcAuto**

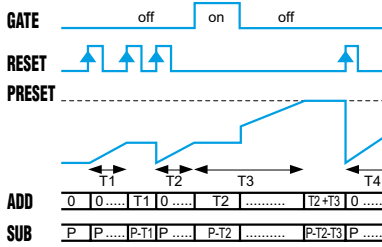

Inp A: No function / Inp B: No function Time counting command via Reset (manual or electrical) / Add: Display 0 → Preset / Sub: Display Preset → 0 The Gate input has a display memory function

**Tachometer: Start tA.A**

INP A	0	FA0	FA1	FA2	0	x
Display	0	0	FA0	FA1	FA2	0

Inp A: Frequency input / Inp B: No function

**Tachometer: Start tA.AS**

INP A	0	FA0	FA1	FA2	0	x
INP B	0	0	FB0	FB1	FB2	x
Display	0	0	FA0	FA0-FB0	FA1-FB1	-FB2

Inp A: Frequency input 1 / Inp B: Frequency input 2 Formula: A - B

**Tachometer: Start tA.AA**

INP A	0	FA0	FA1	FA2	0	x
INP B	0	0	FB0	FB1	FB2	x
Display	0	0	FA0	FA0+FB0	FA1+FB1	FB2

Inp A: Frequency input 1 / Inp B: Frequency input 2 Formula: A + B

**Tachometer: Start tA.PP**

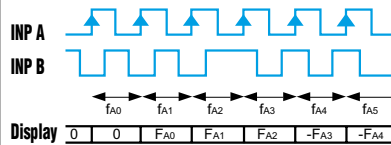

A 90 ° B Inp A: Frequency input / 1 Inp B: Reversal of direction

Output operation: OutoP rS0

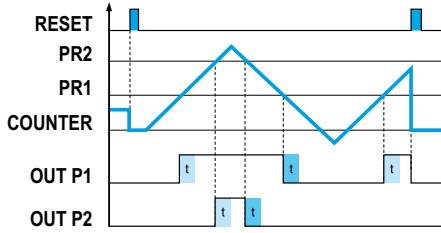

Output operation: OutoP rSA0

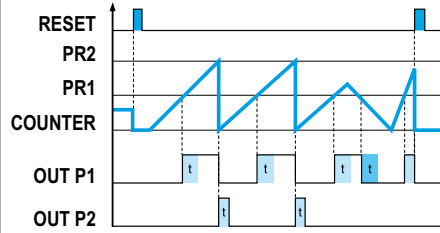

A 90 ° B Inp A: Frequency input / 1 Inp B: Reversal of direction

Output operation: OutoP bCrSA0

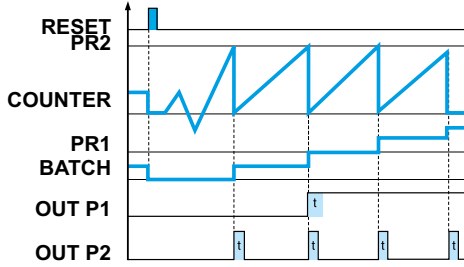

Output operation: OutoP tCrSA0

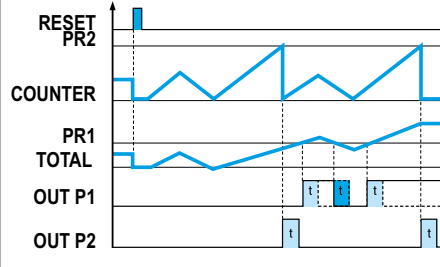

A 90 ° B Inp A: Frequency input / 1 Inp B: Reversal of direction

Output operation: OutoP rSP2

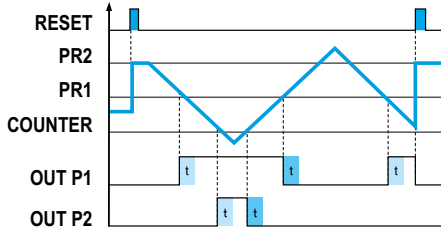

Output operation: OutoP rSAP2

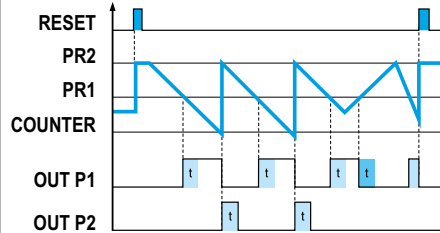

A 90 ° B Inp A: Frequency input / 1 Inp B: Reversal of direction

Output operation: OutoPbCrSA2

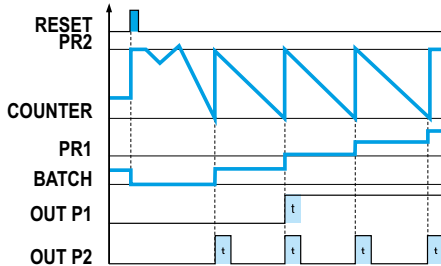

Output operation: OutoP tCrSA2

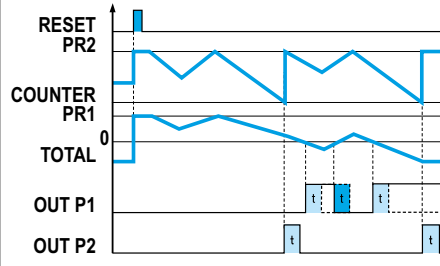

A 90 ° B Inp A: Frequency input / 1 Inp B: Reversal of direction

Output operation: OutoP bCrS0

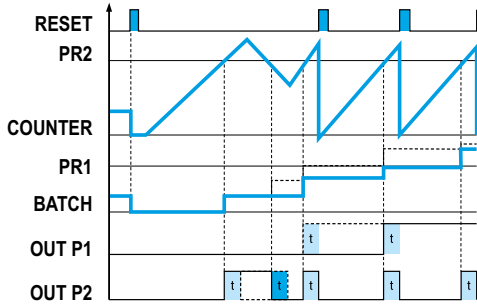

Output operation: OutoP tCrS0

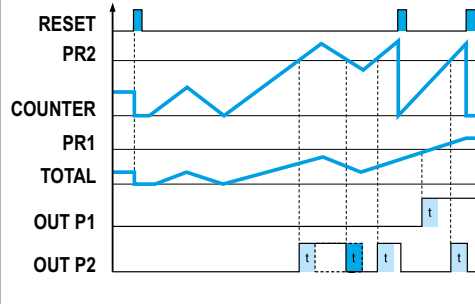

A 90 ° B Inp A: Frequency input / 1 Inp B: Reversal of direction

Output operation: OutoP MurS0 (AA)

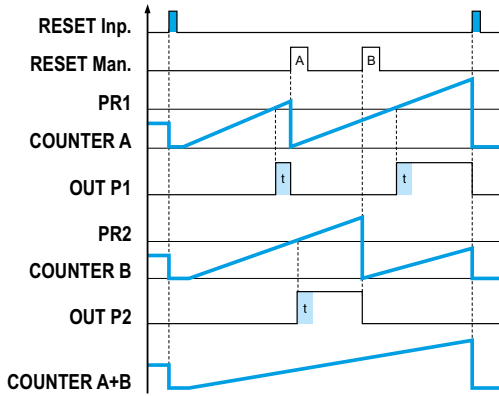

A 90 ° B Inp A: Frequency input / 1 Inp B: Reversal of direction

Output operation: OutoP bCrSP2

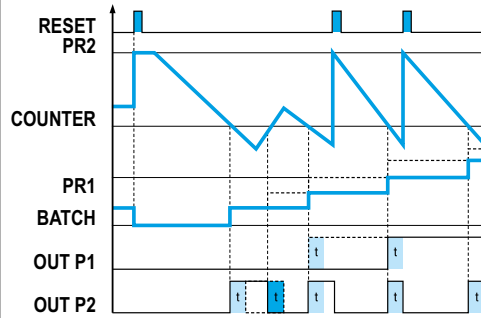

Output operation: OutoP tCrSP2

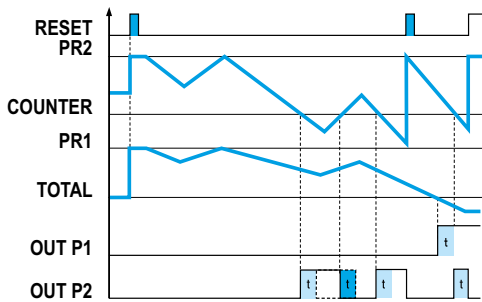

A 90 ° B Inp A: Frequency input / 1 Inp B: Reversal of direction

Output operation: OutoP MurS0 (AS)

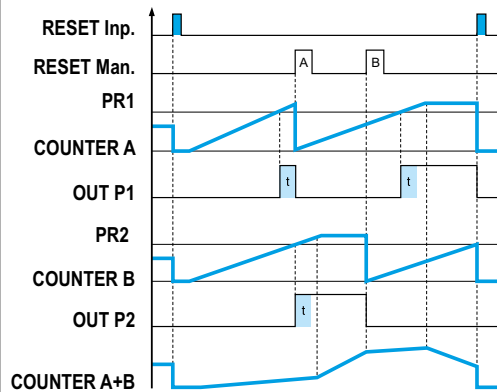

Connections

87621225 - Output: 5 A/250 V~ / AC: 90 → 260 V~

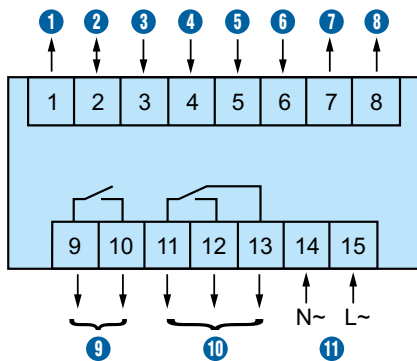

- ① Sensor voltage supply (\* UB interconnected)
- ② GND (0 V~)
- ③ INP A (signal A input)
- ④ INP B (signal B input)
- ⑤ Reset (Reset input)
- ⑥ Gate input
- ⑦ Output 1 - 10-30 V~ / 30 mA
- ⑧ Output 2 - 10-30 V~ / 30 mA
- ⑨ 9-10: Output 1
- ⑩ 11-12-13: Output 1
- ⑪ 14-15: Supply

Applications

Programming diagram

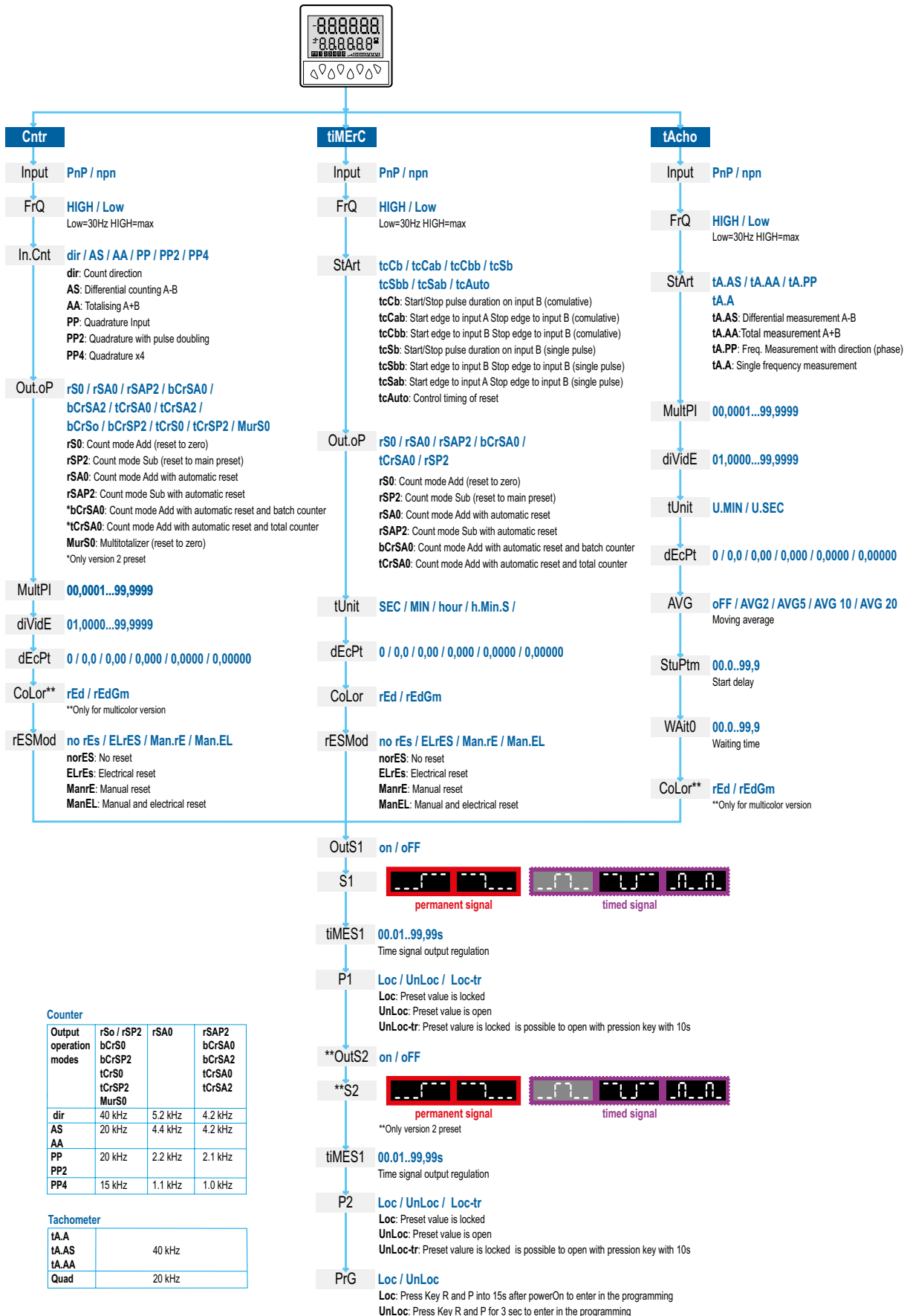

Warning:

The product information contained in this catalogue is given purely as information and does not constitute a representation, warranty or any form of contractual commitment. Crouzet and its subsidiaries reserve the right to modify their products without notice. It is imperative that we should be consulted over any particular use or application of our products and it is the responsibility of the buyer to establish, particularly through all the appropriate tests, that the product is suitable for the use or application. Under no circumstances will our warranty apply, nor shall we be held responsible for any application (such as any modification, addition, deletion, use in conjunction with other electrical or electronic components, circuits or assemblies, or any other unsuitable material or substance) which has not been expressly agreed by us prior to the sale of our products.