

## 17.5 mm EMER8 Part number 88829900



- Multifunction or mono-function
- Multi-range (7 ranges)
- Multi-voltage or single voltage
- Screw terminals
- LED status indicator (1 voltage present LED, 1 timer ON LED)
- Option of supplying a load in parallel (EMER / EMYR)

## Part numbers

	Type	Packaging	Functions	Timing	Output	Nominal rating	Supply voltage
88829900	EMER8	Kit of 60 units	A - At - B - C - D - Di - H - Ht - Pe - W	0,1 →20 h	1 changeover relay	5 A NO	12 →240 V DC / 24 →240 V AC

## Specifications

## Timing

Timing ranges (7 ranges)	0.1 s →1 s / 1 →10 s / 6 →60 s / 1 →10 min / 6 →60 min / 1 →10 h / 2 →20 h
Repetition accuracy with constant parameters	± 0,5 %
Drift Temperature	± 0,05 %/ °C
Drift Voltage	± 0,2 %/V
Display accuracy according to IEC/EN 61812-1	± 10 % / 25 °C
Minimum pulse time	30 ms
Maximum reset time by denegerisation	100 ms

## Supply

Multi-voltage power supply	EMAR2 : 110-120 VAC EMAR7 : 240 VAC EMAR9 : 24 VAC/DC EMER8/EMYR8 : 12 →240 VDC / 24 →240 VAC
Operating range	EMAR2 : 93 to 132VAC EMAR7 : -15 % + 10 % EMAR9 : 24 VAC - 15 % + 10 % / 24 VDC - 15 % + 20 % EMER8/EMYR8 : -15 % + 10 %
Frequency (Hz)	50 / 60 Hz ± 5 %
Max. absorbed power	EMAR2 : approx 3,2 VA 110 VAC EMAR7 : approx. 3,2 VA 230 VAC EMAR9 : approx. 1,2 VA (0,6 W) / 24 VAC (DC) EMER8/EMYR8 : approx. 3,2 VA (1,5 W) / 230 VAC (DC) Approx. 1,2 VA (0,6 W) / 24 VAC (DC)
Immunity from micro power cuts : typical	> 10 ms

## Output specification

Changeover relay	1 NO : 1250 VA / 150 W 1 NC : 750 VA / 90 W
Maximum breaking current	NO : 5 A 250 VAC / 5 A 30 VDC resistive NC : 3 A 250 VAC / 3 A 30 VDC resistive
Minimum breaking current	10 mA / 12 VDC
Voltage breaking capacity	277 VAC / 30 VDC
Electrical life (operations)	10 <sup>5</sup> NO cycles 7 x 10 <sup>4</sup> cycles
Mechanical life (operations cycles)	5 x 10 <sup>6</sup>

## General characteristics

LED display	Green : voltage present Yellow : timer R ON
Fixing : Symmetrical DIN rail	35 mm
Protection (IEC/EN 60529)	Casing : IP40 Connection terminals : IP20
Terminal capacity Multi-wire with ferrule	1 x 0,5 →4 mm <sup>2</sup> (AWG 20 →AWG11) 2 x 0,5 →2,5 mm <sup>2</sup> (AWG 20 →AWG14)
Terminal capacity Single-wire without ferrule	1 x 0,5 →2,5 mm <sup>2</sup> (AWG 20 →AWG14) 2 x 0,5 →1,5 mm <sup>2</sup> (AWG 20 →AWG16)
Stripping length (mm)	5 mm
Max. tightening torques IEC/EN 60947-1	0,6 →0,8 Nm
Temperature limits use (°C)	-20 °C →+60 °C
Temperature limits stored (°C)	-40 °C →70 °C

Relative humidity no condensation acc. to IEC/EN 60068-2-30	93 %
Vibration resistance according to IEC/EN 60068-2-6	10 →55 Hz, A = 0.35 mm peak to peak 10 x cycles, 1 octave/min
Weight (g)	60

### Standard

Certifications	CE - cUL
Conforming to standards (directives BT and CEM)	IEC/EN 61812-1 IEC/EN 61000-6-2 IEC/EN 61000-6-3 IEC/EN 61000-6-4
Conformity with environmental directives	2002/95/CE : RoHS 1907/2006 : Reach
Immunity to electrostatic discharges acc. IEC/EN 61000-4-2	Level III air ± 8 kV / contact ± 4 kV
Immunity to radiated, radio-frequency, electromagnetic field acc. IEC/EN 61000-4-3	Level III 10 V/m (80 M Hz →1 G Hz) 80 % AM (1 K Hz) 3 V/m (1.4 →2 G Hz) 80 % AM (1 K Hz) 1 V/m (2 →2.7 G Hz) 80 % AM (1 K Hz)
Immunity to rapid transient bursts acc. to IEC/EN 61000-4-4	Level III Direct ± 2 kV (power supply) Coupling ± 1 kV (I/O)
Immunity to shock waves on power supply acc. to IEC/EN 61000-4-5	Level III Power supply/earth ± 2 KV Power supply input ± 1 KV
Immunity to radio frequency in common mode acc. to IEC/EN 61000-4-6	Level III 10 V (0.15 →80 M Hz) 80 % AM (1 K Hz)
Immunity to magnetical field acc. (IEC/EN 61000-4-8)	50, 60 Hz 30 A/m, 1 min.
Immunity to voltage dips and breaks acc. to IEC/EN 61000-4-11	0 % residual voltage / 1 cycle 40 % residual voltage / 10 cycles (50 Hz) / 12 cycles (60 Hz) 70 % residual voltage / 25 cycles (50 Hz) / 30 cycles (60 Hz)
Mains-borne and radiated emissions acc. to IEC/EN 61000-6-3	Class B

### Insulation

Insulation voltage	250 V
Insulation coordination (IEC/EN 60664-1)	Category III, degree of pollution 3 ; up to 2000 m
Shock waves	2,5 KV (1,2 / 50 µs)
Breakdown voltage conforming to IEC/EN 61812-1	2 KV / 1 min / 1 mA / 50 Hz
Insulation resistance	> 500 MΩ / 250 V DC / 1 min

### Dimensions (mm)

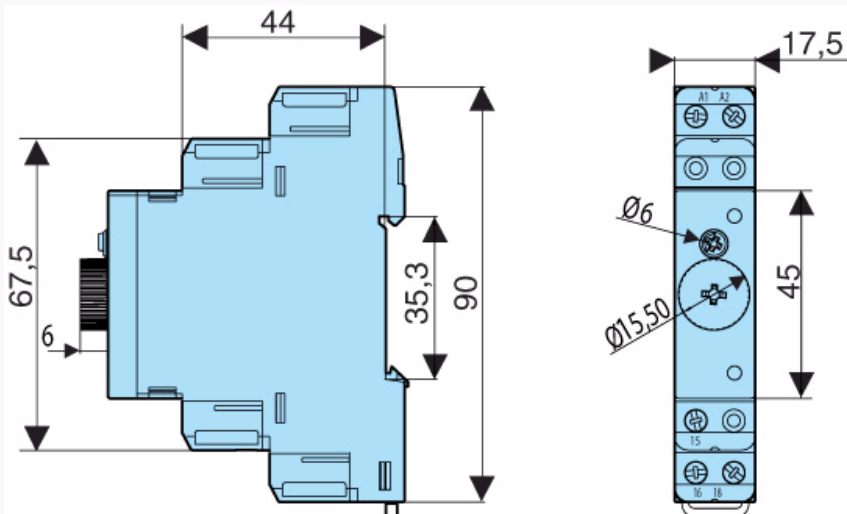

### Curves

#### A function

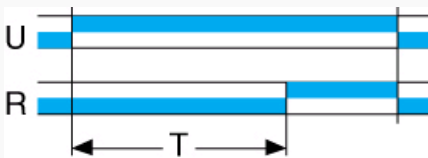

#### Function A

Delay on energisation 1 relay

**Curves**

**At function**

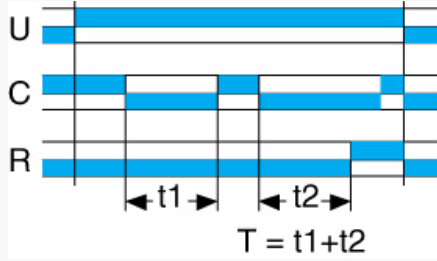

**Function At**

Timing on energisation with memory 1 relay

**Curves**

**B function**

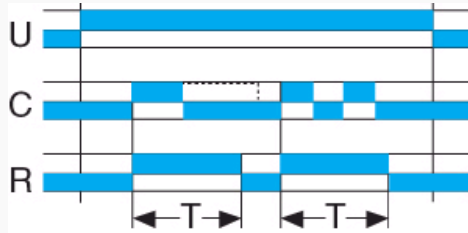

**Function B**

Timing on impulse one shot 1 relay

**Curves**

**C function**

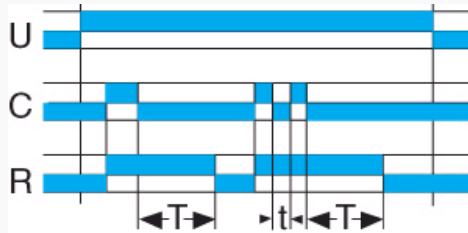

**Function C**

Timing after impulse 1 relay

**Curves**

**D function**

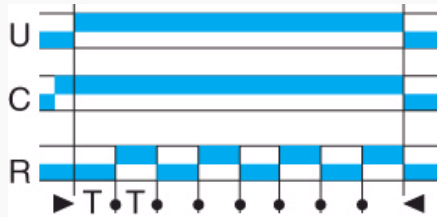

**Function D**

Flip-flop Pause start 1 relay

**Curves**

**Di function**

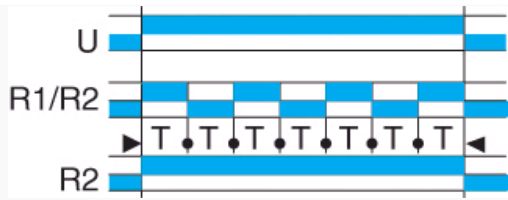

**Function Di**  
 Flip-flop Pulse start 1 relay

**Curves**

**H function**

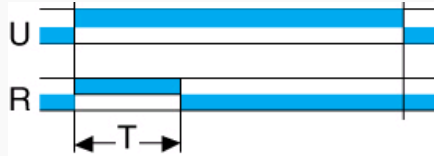

**Function H**  
 Timing on energisation 1 relay

**Curves**

**Ht function**

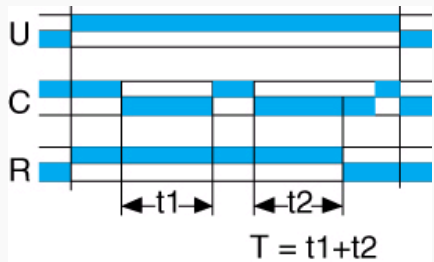

**Function Ht**  
 Delay on energisation with memory 1 relay

**Curves**

**Pe function**

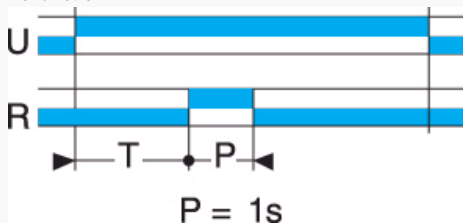

**Function Pe**  
 Impulse counter (delay on) 1 relay

**Curves**

**W function**

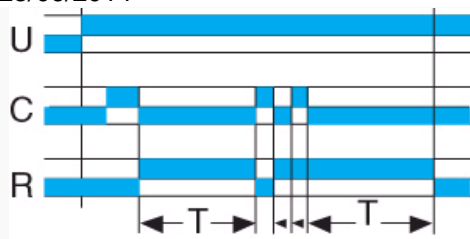

<b>Function W</b>
Timing after pulse on control contact 1 relay

**Connections**

EMER8 - EMYR8

