

48 x 48 Hour counters CHM48 Part number 99772811



- AC : capacity 100,000 hrs (99,999.99 hrs)
- DC : capacity 1,000,000 hrs (999,999.99 hrs)
- Operation indicator
- Panel mounted
- DIN rail mounted with connector base (accessory part number : 26546845)
- IP52
- Highly resistant to shocks and impacts
- Excellent visibility due to the large digit size

Part numbers

	Type	Operating frequency (Hz)	Voltages
99772811	CHM48	DC	36 →80 VDC

Specifications

General characteristics

Counting capacity	VAC : 99 999,99 VDC : 999,999.99
Reset to zero	Not included
Read accuracy	1/100 h
Height digits (mm)	4
Colour of hour numbers	White on a black background
Colour of decimal digits	Red on a black background
Accuracy	VAC : frequency + 30 ms VDC : < 0.003 % (24 hrs)
Counting input mode	Addition
Operation indicator	VAC : rotating red lines VDC : 1/100 hr 1 digit in 36 s
Degree of protection front face	IP52
Mounting	Any
Temperature limits use (°C)	-15 →+50
Temperature limits stored (°C)	-40 →+80
Certifications	UL (pending)
Connections (panel mounted version)	Screw terminals - 6.35 mm Faston connectors
Connections (DIN rail mounted version)	Screw terminals with accessory 26 546 845
Connection capacity	2,5 mm ²
Consumption	VDC : 10 →30 approx. 500 mW/100 →130 approx. 750 mW/ VAC 50 Hz : 20 →30 approx. 0.3 VA/42 →48 approx. 0.25 VA/100 →130 approx. 0.6 VA/187 →264 approx. 1.2 VA/360 →440 approx. 1.65 VA
Vibration resistance	50 m/s ² (10-500 Hz) IEC 68-2-6
Test voltage for AC models	2 000 VAC 50 Hz
Weight (g)	50

Accessories

Description	Code
Adaptor for 72 x 72 mm cut-out	26546842
Adaptor for 55 x 55 mm cut-out	26546846
DIN rail adaptor	26546845

Dimensions (mm)

Panel mounted

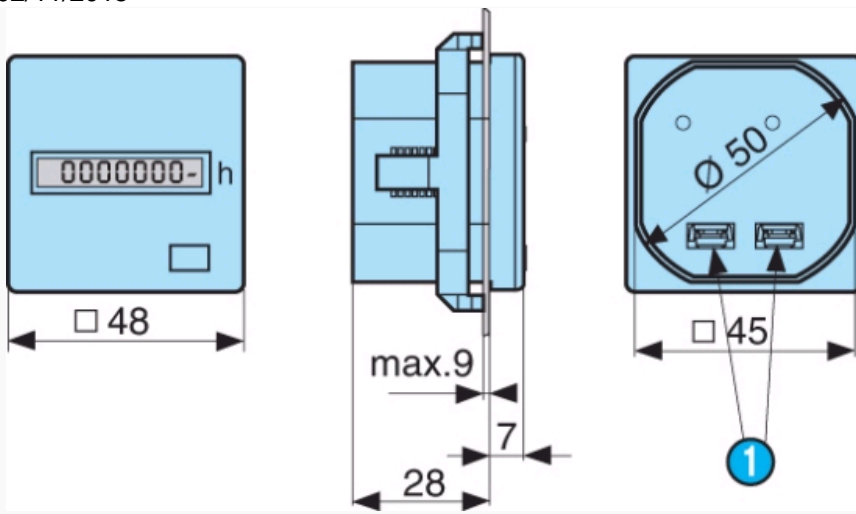

N°	Legend
1	Screw terminals

Dimensions (mm)

Panel cut-out

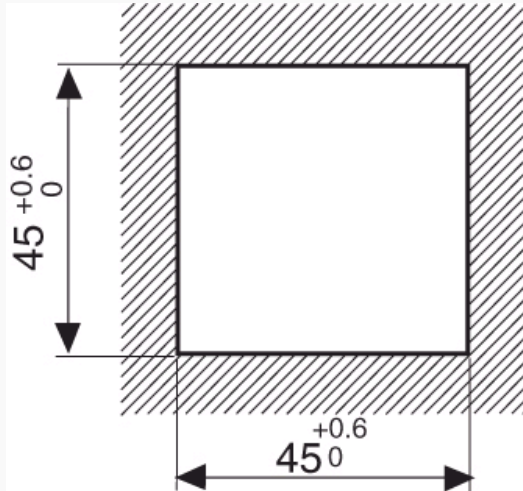

Dimensions (mm)

26546842 - Adaptor for 72 x 72 mm cut-out

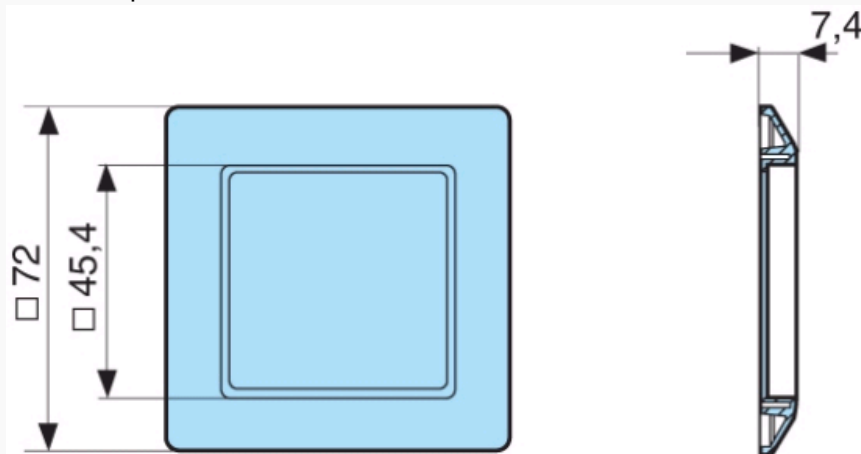

Dimensions (mm)

26546846 - Adaptor for 55 x 55 mm cut-out

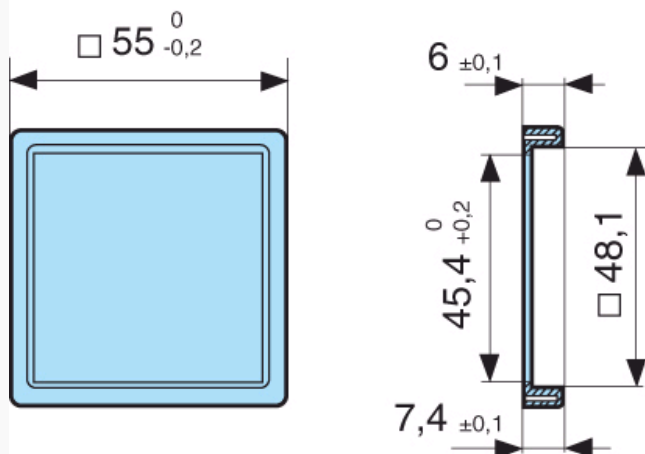

Dimensions (mm)

26546845 - DIN rail mounted

